

# Designer Warmth

Section	Page No.
<b>Towel Rails</b>	
Heated Towel Rail Buying Guide	362
25mm Towel Rails – Metallic Finishes	364
25mm Towel Rails – Colour Finishes	366
25mm Towel Rails – Straight Chrome Finish	368
25mm Towel Rails – Straight White Finish	368
25mm Towel Rails – Straight Anthracite Finish	369
25mm Towel Rails – Straight Matt Black Finish	369

## Designer Towel Rails

### Contemporary Towel Rails

Azerley	370
Broxa	371
Kiso	372
Luna	373
Brierley	374
Voil	374
Muse	375
Shauna	376
Crambeck	377
Ecstasy	378
Nuance	379
<b>new</b> Darton	380
Paros	382
Kinsley	382

### Traditional Towel Rails

Hemsworth	383
-----------	-----

## Designer Radiators

Nostell	384
Lissett	386
Ovate	388
Adore	389
Medley	390
Symphony	391
Alumina	392
Espada Aluminium	394
Espada	396

## Valves

Coloured Valves + Elements	398
Valves	400

## What's new and trending this season...



25mm  
Metallic Finishes  
Page 364



25mm  
Colour Finishes  
Page 366



Darton  
Page 380



Nostell  
Page 384

# Designer Warmth Range Selector

Designer Warmth															
Towel Rails		Heat Source			Finish					Material			Hanging		
Range	Page No.	Heating	Dual Fuel	Electric	Chrome	Polished Stainless Steel	Black	White	Anthracite	Metallic /Colour Finish	Stainless Steel	Mild Steel	Aluminium	Vertical	Horizontal
25mm – Metallic Finishes	364	●	●	●						●		●			●
25mm – Colour Finishes	366	●	●	●						●		●			●
25mm – Straight Finishes	368	●	●	●	●		●	●	●			●			●

Designer Towel Rails															
Azerley	370	●	●	●			●		●				●		●
Broxa	371	●	●	●						●		●			●
Kiso	372	●	●	●		●					●			●	●
Luna	373	●	●	●				●	●				●		●
Brierley	374	●	●	●	●							●			●
Voil	374	●	●	●					●			●			●
Muse	375	●	●	●	●		●					●			●
Shauna	376	●	●	●			●	●				●			●
Crambeck	377	●	●	●	●		●					●			●
Ecstasy	378	●	●	●	●		●					●			●
Nuance	379	●	●	●	●		●					●			●
 Darton	380	●	●	●	●		●			●		●			●
Paros	382	●	●	●	●							●			●
Kinsley	382	●	●	●	●			●				●			●
Hemsworth	383	●	●	●	●			●				●			●

Designer Radiators															
Nostell	384	●					●	●	●				●	●	●
Lissett	386	●					●	●	●				●	●	●
Ovate	388	●						●	●			●		●	
Adore	389	●						●				●		●	●
Medley	390	●						●	●			●		●	●
Symphony	391	●			●		●	●				●		●	
Alumina	392	●						●	●				●	●	●
Espada Aluminium	394	●						●	●				●	●	●
Espada	396	●						●	●			●		●	●

## Designer Warmth Features

There are many features in our designer warmth range. Use the icons to help choose the right option for you.



**Guarantees**  
Our selection of Towel Rails and Radiators have either a 30, 15 or 10 year guarantee.



**Build Material**  
Towel Rails and Radiators are made from either Aluminium, Mild Steel or Stainless Steel.



**Heating**  
For connection to central heating systems.



**Electric**  
Electric only system supply.



**Dual Fuel**  
Capable of running from either central heating or electric system.

**INSTINCT®**

# Heated Towel Rail Buying Guide.

All you need to know about buying the right heated towel rail for your bathroom, cloakroom or en-suite space.

When choosing your heated towel rail, there are a number of factors to consider. To help you make an informed decision, follow our step-by-step guide opposite.

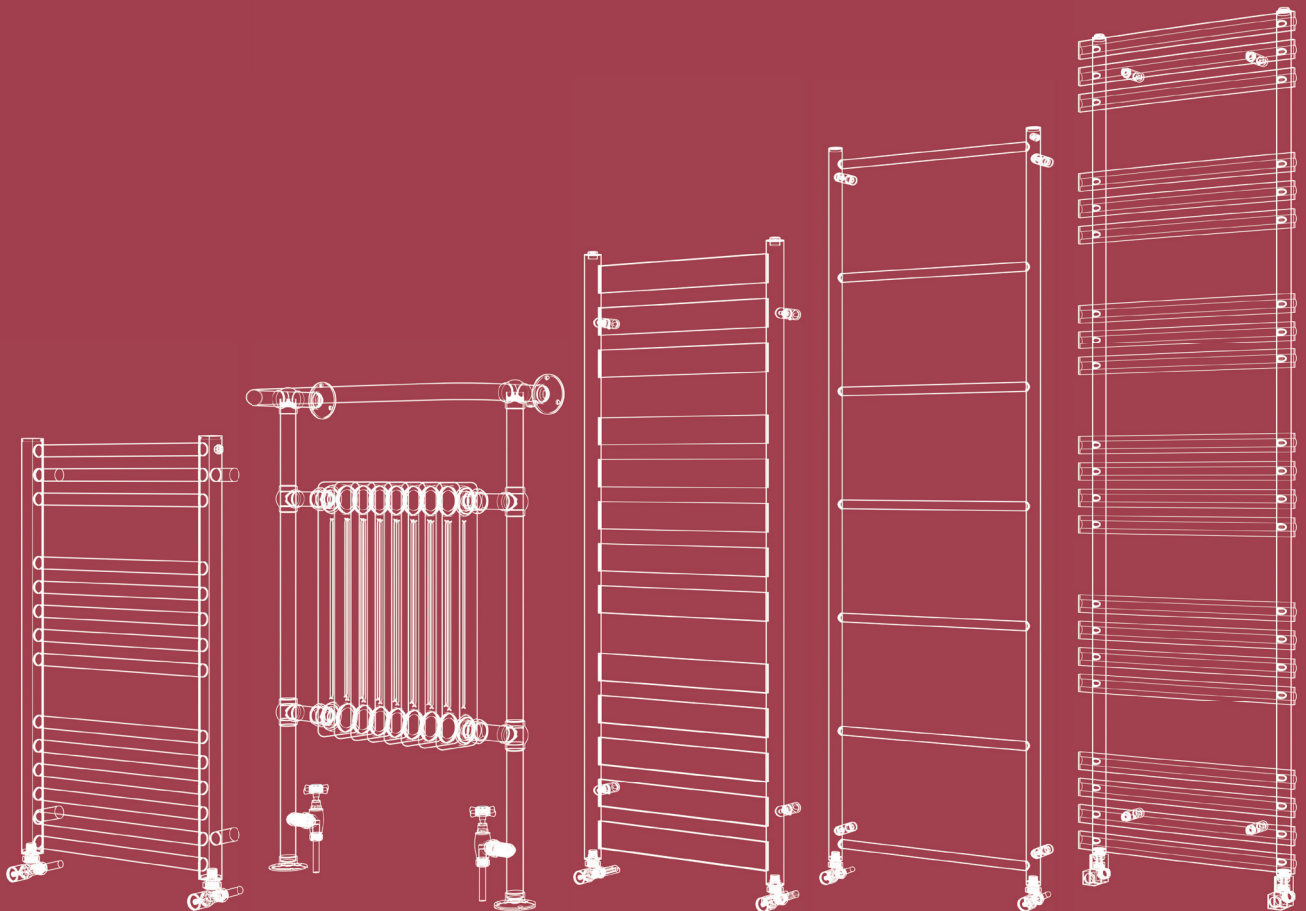

# Heated Towel Rail Buying Guide



## Step 1 Heating Source\*

Your first step is to decide if you are going to connect your towel rail to your central heating system, existing mains electric or run off both as a dual fuel option.



## Step 2 Location

Consider your room size – is it for a family bathroom, downstairs cloakroom or smaller en-suite? Location will determine the size and heat output of the towel rail required.



## Step 3 Heat Output

BTU (British Thermal Unit) output is one of the biggest considerations when deciding your towel rail. The higher the BTU, the higher the heat output will be. Bigger bathrooms need higher BTU rated rails, smaller en-suites lower.

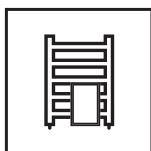

## Step 4 Choose a Style

There are many styles of heated towel rails. Select a Contemporary, Traditional or Ladder style to suit your new bathroom or complement your existing space. Choose from floor standing or wall mounted options; where floor space is at a premium.



## Step 5 Choose a Finish

Select from a wide variety of colours and finishes. Chrome is a very traditional finish but consider new metallic finishes in Brushed Brass, Gunmetal or colour options in Anthracite, Steel Blue or White Sparkle to name a few. The choice is yours!

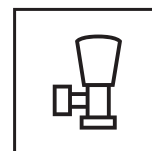

## Step 6 Choose Accessories

Your final step is to choose a complementary valve or heating element accessory.

**So now you know how. Browse through the pages ahead and choose the right option for you.**



## Step 7 How to Order

**All towel rail options are for Hot Water Heating systems only.**

If you wish to order a Sealed Electric option please add the supplement code **PHG-EO-SUPP**.

If you wish to order a Dual Fuel option please add the supplement code **PHG-HE-SUPP**.

**PHG080-50ZAT**

Product Code – Heating

**PHG-HE-SUPP**

Supplement Code – Dual Fuel

**PHG-EO-SUPP**

Supplement Code – Sealed Electric

\*Whatever option you choose, you must use a qualified professional to install it for you.

# 25mm Towel Rails

Guarantees

**15** Years  
on Towel Rails

Heating option supplement applies across all 25mm Straight Towel Rails

PHG-HE-SUPP	Dual fuel add on cost	£91.00
PHG-EO-SUPP	Sealed Electric add on cost	£243.00

## 25mm Straight Towel Rail – Metallic Finishes



Heating option supplement applies across all 25mm Straight Towel Rails

PHG-HE-SUPP	Dual fuel add on cost	£91.00
PHG-EO-SUPP	Sealed Electric add on cost	£243.00

Guarantees

**15** Years on Towel Rails

# 25mm Towel Rails

## Select Your Towel Rail Size + Metallic Finish

Choose from three towel rail sizes in four metallic finish options.

Material – Mild Steel  
 All heat outputs are shown at 50°C ΔT in compliance with BSEN442  
 Rear air vent  
 Contemporary metallic finishes in our popular 25mm horizontal tube multirail.  
 Prices shown are for central heating models

**MS** **H** **DF** **E**

800 x 500mm Straight Towel Rail						
	Finish	Height	Width	Depth	Watts	Btu/hr
PHG080-50BRRS	Brushed Brass	800	500	93	275	938
PHG080-50GM	Gunmetal	800	500	93	275	938
PHG080-50BN	Satin Brushed Nickel	800	500	93	275	938
<b>new</b> PHG080-50BBZ	Brushed Bronze	800	500	93	275	938

1200 x 500mm Straight Towel Rail						
	Finish	Height	Width	Depth	Watts	Btu/hr
PHG120-50BRRS	Brushed Brass	1200	500	93	428	1460
PHG120-50GM	Gunmetal	1200	500	93	428	1460
PHG120-50BN	Satin Brushed Nickel	1200	500	93	428	1460
<b>new</b> PHG120-50BBZ	Brushed Bronze	1200	500	93	428	1460

1800 x 500mm Straight Towel Rail						
	Finish	Height	Width	Depth	Watts	Btu/hr
PHG180-50BRRS	Brushed Brass	1800	500	93	638	2177
PHG180-50GM	Gunmetal	1800	500	93	638	2177
PHG180-50BN	Satin Brushed Nickel	1800	500	93	638	2177
<b>new</b> PHG180-50BBZ	Brushed Bronze	1800	500	93	638	2177

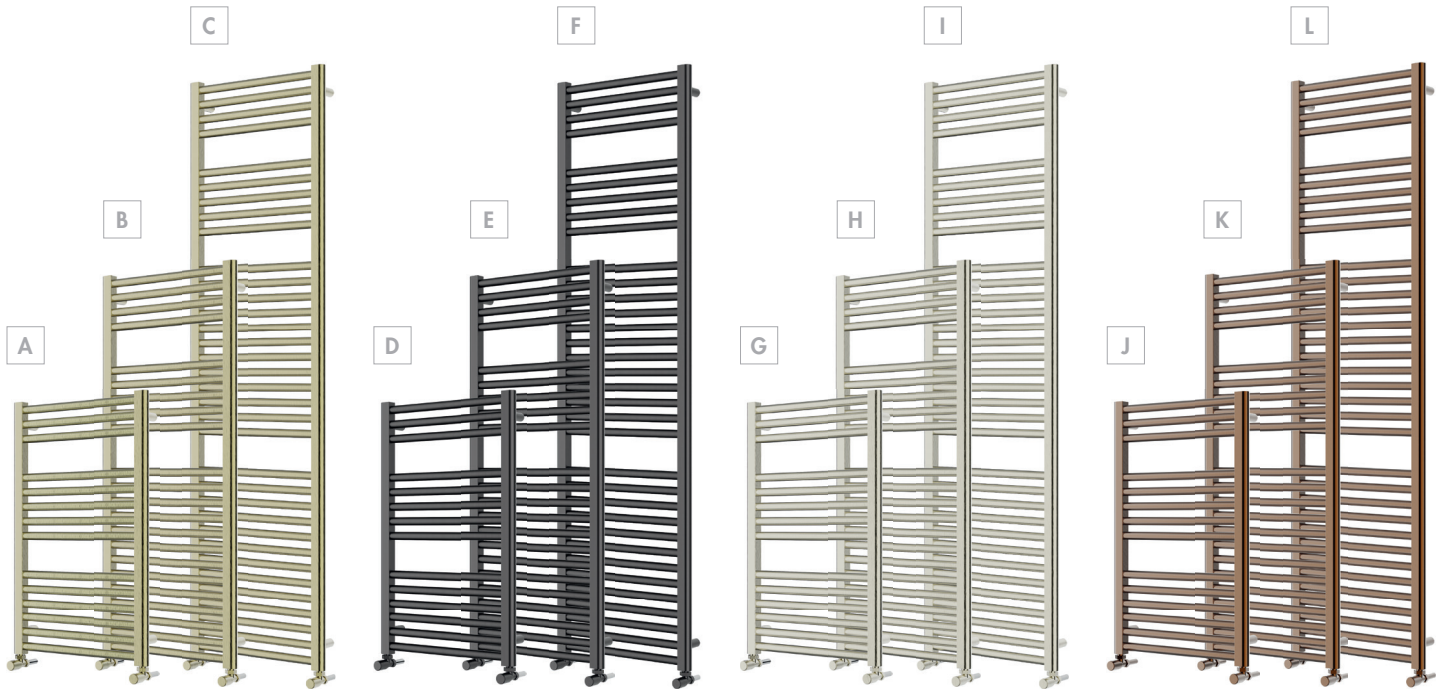

Brushed Brass  
 A PHG080-50BRRS  
 B PHG120-50BRRS  
 C PHG180-50BRRS

Gunmetal  
 D PHG080-50GM  
 E PHG120-50GM  
 F PHG180-50GM

Satin Brushed Nickel  
 G PHG080-50BN  
 H PHG120-50BN  
 I PHG180-50BN

Brushed Bronze  
 J PHG080-50BBZ  
 K PHG120-50BBZ  
 L PHG180-50BBZ

## Select Your Valve Type + Coordinating Metallic Finish



Brushed Brass  
 Straight Valve  
 INCNT003ST-ZBBS

Gunmetal  
 Straight Valve  
 INCNT003ST-ZGM

Satin Brushed Nickel  
 Straight Valve  
 INCNT003ST-ZBN

Gunmetal  
 Angled Valve  
 INCNT003AP-ZGM

Brushed Bronze  
 Angled Valve  
 INCNT003AP-BBZ

Brushed Brass  
 Corner Valve  
 INCNT023-BBS

Brushed Bronze  
 Corner Valve  
 INCNT023-BBZ

Metallic Straight Valves (1/2" x 15mm)		
<b>new</b> INCNT003ST-ZBBS	Brushed Brass	£48.00
<b>new</b> INCNT003ST-ZGM	Gunmetal	£48.00
<b>new</b> INCNT003ST-ZBN	Satin Brushed Nickel	£48.00
<b>new</b> INCNT003ST-BBZ	Brushed Bronze	£48.00

Metallic Angled Valves (1/2" x 15mm)		
<b>new</b> INCNT003AP-ZBBS	Brushed Brass	£48.00
<b>new</b> INCNT003AP-ZGM	Gunmetal	£48.00
<b>new</b> INCNT003AP-ZBN	Satin Brushed Nickel	£48.00
<b>new</b> INCNT003AP-BBZ	Brushed Bronze	£48.00

Metallic Corner Valves (1/2" x 15mm)		
<b>new</b> INCNT023-BBS	Brushed Brass	£58.00
<b>new</b> INCNT023-GM	Gunmetal	£58.00
<b>new</b> INCNT023-BN	Satin Brushed Nickel	£58.00
<b>new</b> INCNT023-BBZ	Brushed Bronze	£58.00

# 25mm Towel Rails

**Guarantees**

**15** Years on Towel Rails

**Heating option supplement applies across all 25mm Straight Towel Rails**

PHG-HE-SUPP	Dual fuel add on cost	£91.00
PHG-EO-SUPP	Sealed Electric add on cost	£243.00

**25mm Straight Towel Rail – Colour Finishes**



Heating option supplement applies across all 25mm Straight Towel Rails

PHG-HE-SUPP	Dual fuel add on cost	£91.00
PHG-EO-SUPP	Sealed Electric add on cost	£243.00

Guarantees

15 Years on Towel Rails

# 25mm Towel Rails

## Select Your Towel Rail Size + Colour Finish

Choose from seven towel rail sizes in seven colour finish options.

Material – Mild Steel

All heat outputs are shown at 50°C ΔT in compliance with BSEN442

Rear air vent

Contemporary painted finishes in our popular 25mm horizontal tube multirail.

Prices shown are for central heating models

MS H DF E

### 800 x 500mm Straight Towel Rail

	Finish	Height	Width	Depth	Watts	Btu/hr	
PHG080-50ZCA	Cappuccino	800	505	74-84	420	1433	£162.00
PHG080-50ZEX	Espresso	800	505	74-84	420	1433	£162.00
PHG080-50ZGS	Grey Sparkle	800	505	74-84	420	1433	£162.00
PHG080-50ZMGN	Moss Green	800	505	74-84	420	1433	£162.00
PHG080-50ZSB	Satin Black	800	505	74-84	420	1433	£162.00
PHG080-50ZSBLU	Steel Blue	800	505	74-84	420	1433	£162.00
PHG080-50ZWS	White Sparkle	800	505	74-84	420	1433	£162.00

### 1200 x 600mm Straight Towel Rail

	Finish	Height	Width	Depth	Watts	Btu/hr	
PHG120-60ZCA	Cappuccino	1200	605	74-84	783	2672	£223.00
PHG120-60ZEX	Espresso	1200	605	74-84	783	2672	£223.00
PHG120-60ZGS	Grey Sparkle	1200	605	74-84	783	2672	£223.00
PHG120-60ZMGN	Moss Green	1200	605	74-84	783	2672	£223.00
PHG120-60ZSB	Satin Black	1200	605	74-84	783	2672	£223.00
PHG120-60ZSBLU	Steel Blue	1200	605	74-84	783	2672	£223.00
PHG120-60ZWS	White Sparkle	1200	605	74-84	783	2672	£223.00

### 1200 x 300mm Straight Towel Rail

	Finish	Height	Width	Depth	Watts	Btu/hr	
PHG120-30ZCA	Cappuccino	1200	305	74-84	424	1447	£178.00
PHG120-30ZEX	Espresso	1200	305	74-84	424	1447	£178.00
PHG120-30ZGS	Grey Sparkle	1200	305	74-84	424	1447	£178.00
PHG120-30ZMGN	Moss Green	1200	305	74-84	424	1447	£178.00
PHG120-30ZSB	Satin Black	1200	305	74-84	424	1447	£178.00
PHG120-30ZSBLU	Steel Blue	1200	305	74-84	424	1447	£178.00
PHG120-30ZWS	White Sparkle	1200	305	74-84	424	1447	£178.00

### 1500 x 500mm Straight Towel Rail

	Finish	Height	Width	Depth	Watts	Btu/hr	
PHG150-50ZCA	Cappuccino	1500	505	74-84	820	2798	£234.00
PHG150-50ZEX	Espresso	1500	505	74-84	820	2798	£234.00
PHG150-50ZGS	Grey Sparkle	1500	505	74-84	820	2798	£234.00
PHG150-50ZMGN	Moss Green	1500	505	74-84	820	2798	£234.00
PHG150-50ZSB	Satin Black	1500	505	74-84	820	2798	£234.00
PHG150-50ZSBLU	Steel Blue	1500	505	74-84	820	2798	£234.00
PHG150-50ZWS	White Sparkle	1500	505	74-84	820	2798	£234.00

### 1200 x 500mm Straight Towel Rail

	Finish	Height	Width	Depth	Watts	Btu/hr	
PHG120-50ZCA	Cappuccino	1200	505	74-84	663	2262	£206.00
PHG120-50ZEX	Espresso	1200	505	74-84	663	2262	£206.00
PHG120-50ZGS	Grey Sparkle	1200	505	74-84	663	2262	£206.00
PHG120-50ZMGN	Moss Green	1200	505	74-84	663	2262	£206.00
PHG120-50ZSB	Satin Black	1200	505	74-84	663	2262	£206.00
PHG120-50ZSBLU	Steel Blue	1200	505	74-84	663	2262	£206.00
PHG120-50ZWS	White Sparkle	1200	505	74-84	663	2262	£206.00

### 1800 x 500mm Straight Towel Rail

	Finish	Height	Width	Depth	Watts	Btu/hr	
PHG180-50ZCA	Cappuccino	1800	505	74-84	969	3306	£281.00
PHG180-50ZEX	Espresso	1800	505	74-84	969	3306	£281.00
PHG180-50ZGS	Grey Sparkle	1800	505	74-84	969	3306	£281.00
PHG180-50ZMGN	Moss Green	1800	505	74-84	969	3306	£281.00
PHG180-50ZSB	Satin Black	1800	505	74-84	969	3306	£281.00
PHG180-50ZSBLU	Steel Blue	1800	505	74-84	969	3306	£281.00
PHG180-50ZWS	White Sparkle	1800	505	74-84	969	3306	£281.00

## Select Your Valve Type + Coordinating Colour Finish



Cappuccino Straight Valve  
INCNT003ST-ZCA



Espresso Straight Valve  
INCNT003ST-ZEX



Grey Sparkle Straight Valve  
INCNT003ST-ZGS



Satin Black Angled Valve  
INCNT003AP-ZSB



Moss Green Angled Valve  
INCNT003AP-ZMGN

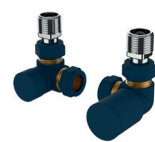

Steel Blue Corner Valve  
INCNT023-SBLU



White Sparkle Corner Valve  
INCNT023-WS

### Straight Valves (1/2" x 15mm)

INCNT003ST-ZCA	Cappuccino	£48.00
INCNT003ST-ZEX	Espresso	£48.00
INCNT003ST-ZGS	Grey Sparkle	£48.00
INCNT003ST-ZMGN	Moss Green	£48.00
INCNT003ST-ZSB	Satin Black	£48.00
INCNT003ST-ZSBLU	Steel Blue	£48.00
INCNT003ST-ZWS	White Sparkle	£48.00

### Angled Valves (1/2" x 15mm)

INCNT003AP-ZCA	Cappuccino	£48.00
INCNT003AP-ZEX	Espresso	£48.00
INCNT003AP-ZGS	Grey Sparkle	£48.00
INCNT003AP-ZMGN	Moss Green	£48.00
INCNT003AP-ZSB	Satin Black	£48.00
INCNT003AP-ZSBLU	Steel Blue	£48.00
INCNT003AP-ZWS	White Sparkle	£48.00

### Corner Valves (1/2" x 15mm)

INCNT023-CA	Cappuccino	£49.00
INCNT023-EX	Espresso	£49.00
INCNT023-GS	Grey Sparkle	£49.00
INCNT023-MGN	Moss Green	£49.00
INCNT023-SB	Satin Black	£49.00
INCNT023-SBLU	Steel Blue	£49.00
INCNT023-WS	White Sparkle	£49.00



# 25mm Towel Rails

Guarantees

**15** Years  
on Towel Rails

Heating option supplement applies across all 25mm Straight Towel Rails

PHG-HE-SUPP	Dual fuel add on cost	£91.00
PHG-EO-SUPP	Sealed Electric add on cost	£243.00

## Straight Towel Rails



Chrome



White

### 25mm Straight Towel Rails

Material – Mild Steel

All heat outputs are shown at 50°C ΔT in compliance with BSEN442

Rear air vent

**MS** **H** **DF** **E**

#### Chrome Finish

	Height	Width	Depth	Watts	Btu/hr	Electric Element	
PHG080-30CP	800	305	80-100	177	604	100	£135.00
PHG080-40CP	800	405	80-100	226	771	125	£162.00
PHG080-50CP	800	505	80-100	275	938	150	£170.00
PHG080-60CP	800	605	80-100	324	1105	200	£192.00
PHG100-50CP	1000	505	80-100	351	1198	200	£222.00
PHG100-60CP	1000	605	80-100	414	1413	200	£244.00
PHG120-30CP	1200	305	80-100	273	931	200	£192.00
PHG120-40CP	1200	405	80-100	350	1194	200	£228.00
PHG120-50CP	1200	505	80-100	428	1460	300	£225.00
PHG120-60CP	1200	605	80-100	505	1723	400	£246.00
PHG150-50CP	1500	505	80-100	534	1822	300	£297.00
PHG150-60CP	1500	605	80-100	631	2153	400	£334.00
PHG180-40CP	1800	405	80-100	521	1778	400	£302.00
PHG180-50CP	1800	505	80-100	638	2177	600	£346.00
PHG180-60CP	1800	605	80-100	754	2573	600	£389.00

#### White Finish

	Height	Width	Depth	Watts	Btu/hr	Electric Element	
PHG080-30WH	800	305	80-100	271	925	100	£94.00
PHG080-40WH	800	405	80-100	346	1181	125	£104.00
PHG080-50WH	800	505	80-100	420	1433	150	£115.00
PHG080-60WH	800	605	80-100	495	1689	200	£129.00
PHG100-50WH	1000	505	80-100	446	1522	200	£150.00
PHG100-60WH	1000	605	80-100	510	1740	200	£164.00
PHG120-30WH	1200	305	80-100	424	1447	200	£132.00
PHG120-40WH	1200	405	80-100	543	1853	200	£138.00
PHG120-50WH	1200	505	80-100	663	2262	300	£154.00
PHG120-60WH	1200	605	80-100	783	2672	400	£170.00
PHG150-50WH	1500	505	80-100	820	2798	300	£171.00
PHG150-60WH	1500	605	80-100	969	3306	400	£187.00
PHG180-40WH	1800	405	80-100	793	2706	400	£204.00
PHG180-50WH	1800	505	80-100	969	3306	600	£218.00
PHG180-60WH	1800	605	80-100	1146	3910	600	£244.00

Heating option supplement applies across all 25mm Straight Towel Rails

PHG-HE-SUPP	Dual fuel add on cost	£91.00
PHG-EO-SUPP	Sealed Electric add on cost	£243.00

Guarantees

**15** Years  
on Towel Rails

# 25mm Towel Rails

## Straight Towel Rails



### 25mm Straight Towel Rails

Material – Mild Steel

All heat outputs are shown at 50°C ΔT in compliance with BSEN442

Rear air vent

**MS** **H** **DF** **E**

#### Anthracite Finish

	Height	Width	Depth	Watts	Btu/hr	Electric Element	
PHG080-50ZAT	800	505	74-84	420	1433	-	£162.00
PHG120-30ZAT	1200	305	74-84	424	1447	-	£178.00
PHG120-50ZAT	1200	505	74-84	663	2262	-	£206.00
PHG120-60ZAT	1200	605	74-84	783	2672	-	£223.00
PHG150-50ZAT	1500	505	74-84	820	2798	-	£234.00
PHG180-50ZAT	1800	505	74-84	969	3306	-	£281.00

#### Matt Black Finish

	Height	Width	Depth	Watts	Btu/hr	Electric Element	
PHG080-50ZMB	800	505	74-84	420	1433	-	£162.00
PHG120-30ZMB	1200	305	74-84	424	1447	-	£178.00
PHG120-50ZMB	1200	505	74-84	663	2262	-	£206.00
PHG120-60ZMB	1200	605	74-84	783	2672	-	£223.00
PHG150-50ZMB	1500	505	74-84	820	2798	-	£234.00
PHG180-50ZMB	1800	505	74-84	969	3306	-	£281.00



Anthracite Straight Valve  
INCNT003ST-ZAT



Matt Black Straight Valve  
INCNT003ST-ZMB



Anthracite Angled Valve  
INCNT003AP-ZAT



Matt Black Angled Valve  
INCNT003AP-ZMB



Anthracite Corner Valve  
INCNT023-AT



Matt Black Corner Valve  
INCNT023-MB

#### Straight Valves (½" x 15mm)

INCNT003ST-ZAT	Anthracite	£48.00
INCNT003ST-ZMB	Matt Black	£48.00

#### Angled Valves (½" x 15mm)

INCNT003AP-ZAT	Anthracite	£48.00
INCNT003AP-ZMB	Matt Black	£48.00

#### Corner Valves (½" x 15mm)

INCNT023-AT	Anthracite	£49.00
INCNT023-MB	Matt Black	£49.00

# Azerley

**Guarantees**

**10** Years  
on Azerley

Heating option supplement applies across all Designer Towel Rails

PHG-HE-SUPP	Dual fuel add on cost	£91.00
PHG-EO-SUPP	Sealed Electric add on cost	£243.00



Matt Black  
1000 x 500mm  
AZ1000500MB



**Azerley**

Finish – Matt Black or Anthracite  
Material – Aluminium

All heat outputs are shown at 50°C ΔT in compliance with BSEN442.

For details on up-grading from standard elements to Thermostatic or Remote Control, please see page 399. Please see pages 400-401 for our range of valves.

**AL H DF E**

**Matt Black Finish**

	Height	Width	Depth	Bars	Pipe Centres	Watts	Btu/hr	
AZ0700500MB	700	500	72-81	3	455	329	1123	£388.00
AZ1000500MB	1000	500	72-81	4	455	446	1522	£486.00
AZ1300500MB	1300	500	72-81	5	455	563	1921	£597.00
AZ1600500MB	1600	500	72-81	6	455	681	2324	£691.00

**Anthracite Finish**

	Height	Width	Depth	Bars	Pipe Centres	Watts	Btu/hr	
AZ0700500AT	700	500	72-81	3	455	329	1123	£393.00
AZ1000500AT	1000	500	72-81	4	455	446	1522	£493.00
AZ1300500AT	1300	500	72-81	5	455	563	1921	£606.00
AZ1600500AT	1600	500	72-81	6	455	681	2324	£702.00



Anthracite 700 x 500mm AZ0700500AT  
 Anthracite 1000 x 500mm AZ1000500AT  
 Anthracite 1300 x 500mm AZ1300500AT  
 Anthracite 1600 x 500mm AZ1600500AT

All dimensions in mm. All measurements are approximate and subject to standard tolerances.

INSTINCT®

Designer Towel Rails

**Heating option supplement applies across all Designer Towel Rails**

<b>PHG-HE-SUPP</b>	Dual fuel add on cost	£91.00
<b>PHG-EO-SUPP</b>	Sealed Electric add on cost	£243.00

**Guarantees**

**15** Years  
on Broxa

Broxa



Brushed Brass  
1200 x 500mm  
BR12050BR

**Broxa**

Finish – Brushed Brass

Material – Mild Steel

All heat outputs are shown at 50°C ΔT in compliance with BSEN442.

For details on up-grading from standard elements to Thermostatic or Remote Control, please see page 399. Please see pages 400-401 for our range of valves.

**MS** **H** **DF** **E**



Brushed Brass  
800 x 500mm  
BR0850BR

Brushed Brass  
1200 x 500mm  
BR12050BR

Brushed Brass  
1600 x 500mm  
BR16050BR

	Height	Width	Depth	Bars	Pipe Centres	Watts	Btu/hr	
<b>new</b> BR0850BR	800	500	102	2-3-3	450	-	994	£458.00
BR12050BR	1200	500	102	3-4-5	450	-	1491	£642.00
<b>new</b> BR16050BR	1600	500	102	3-4-4-5	450	-	1987	£825.00

# Kiso

**Guarantees**

**30** Years on Kiso

**Heating option supplement applies across all Designer Towel Rails**

<b>PHG-HE-SUPP</b>	Dual fuel add on cost	£91.00
<b>PHG-EO-SUPP</b>	Sealed Electric add on cost	£243.00



Polished Stainless Steel  
1200 x 500mm  
**KI-S1250S**



Polished Stainless Steel  
600 x 1000mm  
**TO0601000PS**

**Kiso**

Finish – Polished Stainless Steel Material – Stainless Steel  
All heat outputs are shown at 50°C ΔT in compliance with BSEN442.  
Watts and Btu's apply to Heating and Dual Fuel only.  
For details on up-grading from standard elements to Thermostatic or Remote Control, please see page 399. Please see pages 400-401 for our range of valves.

STAINLESS STEEL **H** **DF** **E**

**Straight**

	Height	Width	Depth	Bars	Pipe Centres	Watts	Btu/hr	
<b>KI-S0850S</b>	800	500	100	3-4-5	468	243	829	£517.00
<b>KI-S0860S</b>	800	600	100	3-4-5	568	269	918	£577.00
<b>KI-S1250S</b>	1200	500	100	3-4-5-6	468	348	1187	£695.00
<b>KI-S1260S</b>	1200	600	100	3-4-5-6	568	402	1372	£799.00
<b>KI-S1650S</b>	1600	500	100	3-4-5-6-6	468	464	1583	£990.00
<b>KI-S1660S</b>	1600	600	100	3-4-5-6-6	568	536	1829	£1020.00

**Horizontal**

	Height	Width	Depth	Bars	Pipe Centres	Watts	Btu/hr	
<b>TO0600750PS</b>	600	750	100	4-5	718	419	1430	£550.00
<b>TO0601000PS</b>	600	1000	100	4-5	968	517	1764	£635.00
<b>TO0800750PS</b>	800	750	100	3-4-5	718	529	1805	£669.00
<b>TO0801000PS</b>	800	1000	100	3-4-5	968	682	2327	£731.00

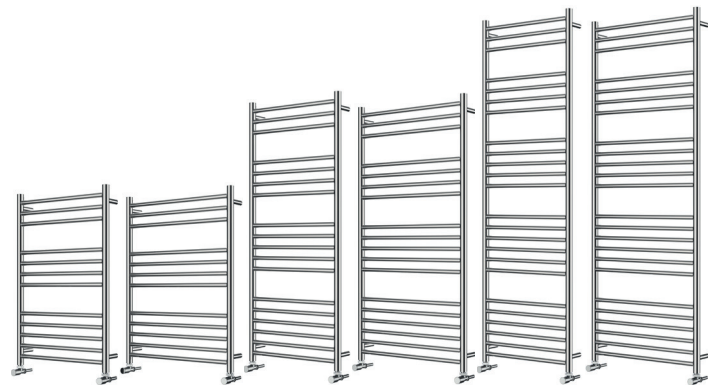

800 x 500mm **KI-S0850S**    800 x 600mm **KI-S0860S**    1200 x 500mm **KI-S1250S**    1200 x 600mm **KI-S1260S**    1600 x 500mm **KI-S1650S**    1600 x 600mm **KI-S1660S**



600 x 750mm **TO0600750PS**    600 x 1000mm **TO0601000PS**    800 x 750mm **TO0800750PS**    800 x 1000mm **TO0801000PS**

All dimensions in mm. All measurements are approximate and subject to standard tolerances.

INSTINCT®

Designer Towel Rails

**Heating option supplement applies across all Designer Towel Rails**

<b>PHG-HE-SUPP</b>	Dual fuel add on cost	£91.00
<b>PHG-EO-SUPP</b>	Sealed Electric add on cost	£243.00

**Guarantees**

**10** Years on Luna

**Luna**



Anthracite  
1200 x 500mm  
LUN12050AT



White  
1200 x 500mm  
LUN12050WH

**Luna**

Finish – Anthracite or White

Material – Aluminium

All heat outputs are shown at 50°C ΔT in compliance with BSEN442.

Watts and Btu's apply to Heating and Dual Fuel only. Watts 600 on Electric only model.

For details on up-grading from standard elements to Thermostatic or Remote Control, please see pages 399. Please see pages 400-401 for our range of valves.

**AL H DF E**

Anthracite Finish									
	Height	Width	Depth	Bars	Pipe Centres	Watts	Btu/hr		
<b>LUN12050AT</b>	1200	500	100	3-3-4	470	778	2655	£505.00	
<b>LUN16050AT</b>	1600	500	100	3-3-3-4	470	1043	3560	£593.00	

White Finish									
	Height	Width	Depth	Bars	Pipe Centres	Watts	Btu/hr		
<b>LUN12050WH</b>	1200	500	100	3-3-4	470	778	2655	£490.00	
<b>LUN16050WH</b>	1600	500	100	3-3-3-4	470	1043	3560	£578.00	



Anthracite  
1200 x 500mm  
LUN12050AT

Anthracite  
1600 x 500mm  
LUN16050AT

White  
1200 x 500mm  
LUN12050WH

White  
1600 x 500mm  
LUN16050WH

# Brierley / Voil

**Guarantees**

**15** Years  
on Brierley + Voil

**Heating option supplement applies across all Designer Towel Rails**

<b>PHG-HE-SUPP</b>	Dual fuel add on cost	£91.00
<b>PHG-EO-SUPP</b>	Sealed Electric add on cost	£243.00



Chrome  
1200 x 500mm  
**BRIERL1200500CP**

**Brierley**

Finish – Chrome  
Material – Mild Steel  
All heat outputs are shown at 50°C ΔT in compliance with BSEN442.  
For details on up-grading from standard elements to Thermostatic or Remote Control, please see page 399. Please see pages 400-401 for our range of valves.

**MS H DF E**

	Height	Width	Depth	Bars	Pipe Centres	Watts	Btu/hr		
<b>BRIERL1200500CP</b>	1200	500	125-137	3-3-3	80	237	809	£553.00	
<b>BRIERL1500500CP</b>	1500	500	125-137	3-3-3-3	80	309	1054	£630.00	

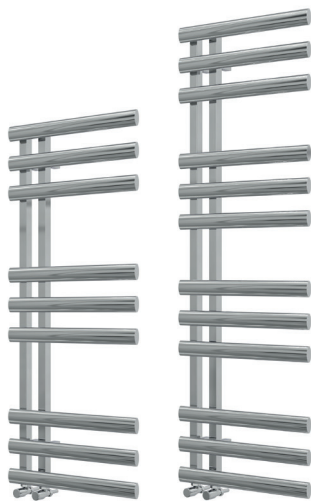

Chrome  
1200 x 500mm  
**BRIERL1200500CP**

Chrome  
1500 x 500mm  
**BRIERL1500500CP**



Anthracite  
850 x 500mm  
**VOIL0850500AT**

**Voil**

Finish – Anthracite  
Material – Mild Steel  
All heat outputs are shown at 50°C ΔT in compliance with BSEN442.  
Watts and Btu's apply to Heating and Dual Fuel only.  
For details on up-grading from standard elements to Thermostatic or Remote Control, please see page 399. Please see pages 400-401 for our range of valves.

**MS H DF E**

	Height	Width	Depth	Bars	Pipe Centres	Watts	Btu/hr		
<b>VOIL0850500AT</b>	850	500	125	2-3-3	300	524	1788	£311.00	
<b>VOIL1200500AT</b>	1200	500	125	2-3-3-3	300	683	2330	£400.00	
<b>VOIL1550500AT</b>	1550	500	125	3-3-4-6	300	966	3296	£517.00	



Anthracite  
850 x 500mm  
**VOIL0850500AT**

Anthracite  
1200 x 500mm  
**VOIL1200500AT**

Anthracite  
1550 x 500mm  
**VOIL1550500AT**

All dimensions in mm. All measurements are approximate and subject to standard tolerances.

INSTINCT®

Designer Towel Rails

Heating option supplement applies across all Designer Towel Rails

PHG-HE-SUPP	Dual fuel add on cost	£91.00
PHG-EO-SUPP	Sealed Electric add on cost	£243.00

Guarantees

15 Years on Muse

Muse



Muse

Finish – Chrome or Matt Black

Material – Mild Steel

All heat outputs are shown at 50°C ΔT in compliance with BSEN442.

For details on up-grading from standard elements to Thermostatic or Remote Control, please see page 399. Please see pages 400-401 for our range of valves.

MS H DF E

Chrome Finish							
	Height	Width	Depth	Bars	Pipe Centres	Watts	Btu/hr
MU1200500CP	1200	500	118	3-3-3-3-3	60	354	1208
MU1400600CP	1400	600	118	3-3-3-3-3-3	60	436	1488

Matt Black Finish							
	Height	Width	Depth	Bars	Pipe Centres	Watts	Btu/hr
MU1200500MB	1200	500	118	3-3-3-3-3	60	442	1508
MU1400600MB	1400	600	118	3-3-3-3-3-3	60	545	1859

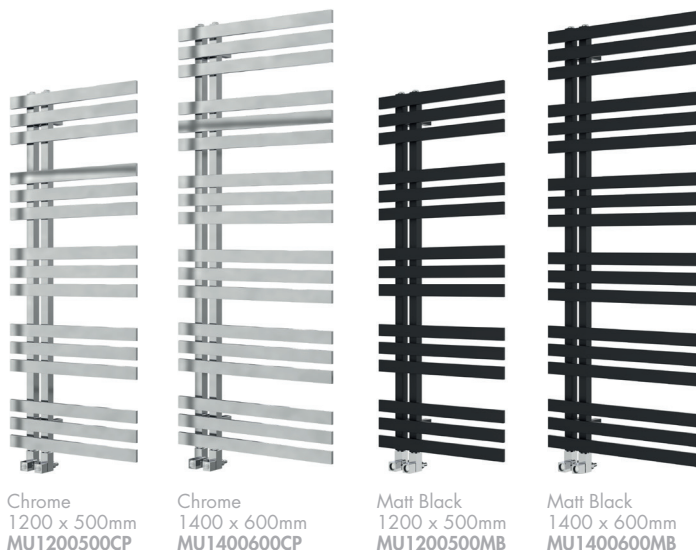



# Shauna

**Guarantees**

**15** Years  
on Shauna

Heating option supplement applies across all Designer Towel Rails

PHG-HE-SUPP	Dual fuel add on cost	£91.00
PHG-EO-SUPP	Sealed Electric add on cost	£243.00



Matt Black  
1500 x 500mm  
SHAUNA1500500MB

**Shauna**

Finish – Matt Black or White Sparkle  
Material – Mild Steel

All heat outputs are shown at 50°C ΔT in compliance with BSEN442.

For details on up-grading from standard elements to Thermostatic or Remote Control, please see page 399. Please see pages 400-401 for our range of valves.

**MS H DF E**

**Matt Black Finish**

	Height	Width	Depth	Bars	Pipe Centres	Watts	Btu/hr	£
SHAUNA0800500MB	800	500	105-120	3-7	50	447	1525	£461.00
SHAUNA1200500MB	1200	500	105-120	3-5-7	50	628	2143	£573.00
SHAUNA1500500MB	1500	500	105-120	3-4-5-7	50	770	2627	£651.00

**White Sparkle Finish**

	Height	Width	Depth	Bars	Pipe Centres	Watts	Btu/hr	£
SHAUNA0800500WS	800	500	105-120	3-7	50	447	1525	£461.00
SHAUNA1200500WS	1200	500	105-120	3-5-7	50	628	2143	£573.00
SHAUNA1500500WS	1500	500	105-120	3-4-5-7	50	770	2627	£651.00

Matt Black  
1500 x 500mm  
SHAUNA1500500MB

White Sparkle  
1500 x 500mm  
SHAUNA1500500WS

Matt Black  
1200 x 500mm  
SHAUNA1200500MB

White Sparkle  
1200 x 500mm  
SHAUNA1200500WS



Matt Black  
800 x 500mm  
SHAUNA0800500MB

White Sparkle  
800 x 500mm  
SHAUNA0800500WS

All dimensions in mm. All measurements are approximate and subject to standard tolerances.

INSTINCT®

Designer Towel Rails

**Heating option supplement applies across all Designer Towel Rails**

PHG-HE-SUPP	Dual fuel add on cost	£91.00
PHG-EO-SUPP	Sealed Electric add on cost	£243.00

**Guarantees**

**15** Years on Crambeck

# Crambeck



Chrome  
1800 x 500mm  
CRAMBECK18050CP



Matt Black  
1800 x 500mm  
CRAMBECK18050MB

**Crambeck**

Finish – Chrome or Matt Black

Material – Mild Steel

All heat outputs are shown at 50°C ΔT in compliance with BSEN442.

For details on up-grading from standard elements to Thermostatic or Remote Control, please see page 399. Please see pages 400-401 for our range of valves.



Chrome Finish								
	Height	Width	Depth	Bars	Pipe Centres	Watts	Btu/hr	
CRAMBECK08050CP	828	500	95	3-3-4	430	232	792	£489.00
CRAMBECK12050CP	1200	500	95	3-4-4-4	430	346	1181	£626.00
CRAMBECK18050CP	1800	500	95	3-3-3-4-4-4	430	491	1675	£787.00

Matt Black Finish								
	Height	Width	Depth	Bars	Pipe Centres	Watts	Btu/hr	
CRAMBECK08050MB	828	500	95	3-3-4	430	290	989	£416.00
CRAMBECK12050MB	1200	500	95	3-4-4-4	430	432	1474	£528.00
CRAMBECK18050MB	1800	500	95	3-3-3-4-4-4	430	614	2095	£666.00

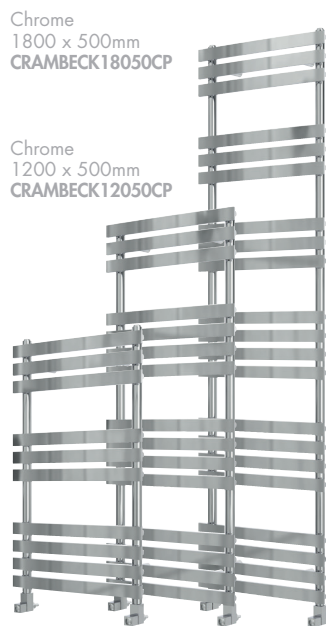

Chrome  
828 x 500mm  
CRAMBECK08050CP



Matt Black  
828 x 500mm  
CRAMBECK08050MB

# Ecstasy

**Guarantees**

**15** Years  
on Ecstasy

**Heating option supplement applies across all Designer Towel Rails**

PHG-HE-SUPP	Dual fuel add on cost	£91.00
PHG-EO-SUPP	Sealed Electric add on cost	£243.00



Matt Black  
1300 x 500mm  
EC1300500MB



Brushed Brass  
1300 x 500mm  
EC1300500BB

**Ecstasy**

Finish – Chrome, Matt Black or Brushed Brass  
Material – Mild Steel

All heat outputs are shown at 50°C ΔT in compliance with BSEN442.

Watts and Btu's apply to Heating and Dual Fuel only.

For details on up-grading from standard elements to Thermostatic or Remote Control, please see page 399. Please see pages 400-401 for our range of valves.

**MS H DF E**

Chrome Finish								
	Height	Width	Depth	Bars	Pipe Centres	Watts	Btu/hr	
EC0950C	950	500	82	2-3-4	462	246	839	£322.00
EC1350C	1300	500	82	3-5-5	462	330	1126	£352.00

Matt Black Finish								
	Height	Width	Depth	Bars	Pipe Centres	Watts	Btu/hr	
EC0950500MB	950	500	82	2-3-4	462	289	986	£306.00
EC1300500MB	1300	500	82	3-5-5	462	389	1327	£458.00

Brushed Brass Finish								
	Height	Width	Depth	Bars	Pipe Centres	Watts	Btu/hr	
<b>new</b> EC0950500BB	950	500	84	2-3-4	462	299	1021	£500.00
<b>new</b> EC1300500BB	1300	500	84	3-5-5	462	426	1453	£677.00

Chrome  
1300 x 500mm  
EC1350C

Matt Black  
1300 x 500mm  
EC1300500MB

Brushed Brass  
1300 x 500mm  
EC1300500BB



Chrome  
950 x 500mm  
EC0950C

Matt Black  
950 x 500mm  
EC0950500MB

Brushed Brass  
950 x 500mm  
EC0950500BB

All dimensions in mm. All measurements are approximate and subject to standard tolerances.

INSTINCT®

Designer Towel Rails

**Heating option supplement applies across all Designer Towel Rails**

<b>PHG-HE-SUPP</b>	Dual fuel add on cost	£91.00
<b>PHG-EO-SUPP</b>	Sealed Electric add on cost	£243.00

**Guarantees**

**15** Years on Nuance

# Nuance



## Nuance

Finish – Chrome or Matt Black Material – Mild Steel

All heat outputs are shown at 50°C ΔT in compliance with BSEN442.

Watts and Btu's apply to Heating and Dual Fuel only.

For details on up-grading from standard elements to Thermostatic or Remote Control, please see page 399. Please see pages 400-401 for our range of valves.

**MS** **H** **DF** **E**

**Chrome Finish**

	Height	Width	Depth	Bars	Pipe Centres	Watts	Btu/hr	
<b>NU1050C</b>	1000	500	80	12	470	257	877	£335.00
<b>NU1150C</b>	1165	500	80	15	470	314	1071	£379.00
<b>NU1160C</b>	1165	600	80	15	570	365	1245	£420.00
<b>NU1750C</b>	1700	500	80	20	470	434	1481	£494.00

**Matt Black Finish**

	Height	Width	Depth	Bars	Pipe Centres	Watts	Btu/hr	
<b>NU1000500MB</b>	1000	500	80	12	470	409	1396	£310.00
<b>NU1165500MB</b>	1165	500	80	15	470	420	1433	£342.00
<b>NU1165600MB</b>	1165	600	80	15	570	437	1491	£374.00
<b>NU1700500MB</b>	1700	500	80	20	470	501	1709	£403.00



# Darton

**Guarantees**

**15** Years on Darton

**Heating option supplement applies across all Designer Towel Rails**

<b>PHG-HE-SUPP</b>	Dual fuel add on cost	£91.00
<b>PHG-EO-SUPP</b>	Sealed Electric add on cost	£243.00



Chrome  
1193 x 498mm  
DA1195C



Matt Black  
1193 x 498mm  
DA1195MB

**Darton**

Finish – Chrome, Matt Black or Brushed Brass

Material – Mild Steel

All heat outputs are shown at 50°C ΔT in compliance with BSEN442.

Watts and Btu's apply to Heating and Dual Fuel only.

For details on up-grading from standard elements to Thermostatic or Remote Control, please see page 399. Please see pages 400-401 for our range of valves.

**MS H DF E**

**Chrome Finish**

	Height	Width	Depth	Bars	Pipe Centres	Watts	Btu/hr	
<b>DA750C</b>	748	498	124	4	425	169	577	£559.00
<b>DA1195C</b>	1193	498	125	5	425	201	686	£795.00
<b>DA1550C</b>	1548	498	125	6	425	312	1063	£884.00

**Matt Black Finish**

	Height	Width	Depth	Bars	Pipe Centres	Watts	Btu/hr	
<b>DA750MB</b>	748	498	124	4	425	186	635	£470.00
<b>DA1195MB</b>	1193	498	125	5	425	321	1096	£706.00
<b>DA1550MB</b>	1548	498	125	6	425	394	1346	£795.00

**Brushed Brass Finish**

	Height	Width	Depth	Bars	Pipe Centres	Watts	Btu/hr	
<b>DA750BB</b>	748	498	130	4	425	171	584	£678.00
<b>DA1195BB</b>	1193	498	130	5	425	269	916	£854.00
<b>DA1550BB</b>	1548	498	130	6	425	410	1399	£1002.00



Chrome  
748 x 498mm  
DA750C

Chrome  
1193 x 498mm  
DA1195C

Chrome  
1548 x 498mm  
DA1550C

All dimensions in mm. All measurements are approximate and subject to standard tolerances.

INSTINCT®

Designer Towel Rails

Heating option supplement applies across all Designer Towel Rails

PHG-HE-SUPP	Dual fuel add on cost	£91.00
PHG-EO-SUPP	Sealed Electric add on cost	£243.00

Guarantees

**15** Years  
on Darton

Darton



Brushed Brass  
1193 x 498mm  
DA1195BB



Matt Black  
748 x 498mm  
DA750MB

Matt Black  
1193 x 498mm  
DA1195MB

Matt Black  
1548 x 498mm  
DA1550MB



Brushed Brass  
748 x 498mm  
DA750BB

Brushed Brass  
1193 x 498mm  
DA1195BB

Brushed Brass  
1548 x 498mm  
DA1550BB

# Paros / Kinsley

**Guarantees**

**15** Years  
on Paros + Kinsley

**Heating option supplement applies across all Designer Towel Rails**

<b>PHG-HE-SUPP</b>	Dual fuel add on cost	£91.00
<b>PHG-EO-SUPP</b>	Sealed Electric add on cost	£243.00



**Paros**

Finish – Chrome  
Material – Mild Steel  
All heat outputs are shown at 50°C ΔT in compliance with BSEN442.  
Watts and Btu's apply to Heating and Dual Fuel only.  
For details on up-grading from standard elements to Thermostatic or Remote Control, please see page 399. Please see pages 400-401 for our range of valves.

**MS H DF E**

	Height	Width	Depth	Bars	Watts	Btu/hr	
<b>PA0772500CP</b>	772	500	80-95	3-5-5	290	989	£257.00
<b>PA0772600CP</b>	772	600	80-95	3-5-5	347	1184	£277.00
<b>PA1186500CP</b>	1186	500	80-95	5-5-5-5	465	1587	£356.00
<b>PA1508500CP</b>	1508	500	80-95	5-5-5-5-5	581	1982	£436.00
<b>PA1738500CP</b>	1738	500	80-95	6-6-6-6-6	687	2344	£501.00

**Kinsley**

Finish – Chrome and White  
Material – Mild Steel  
All heat outputs are shown at 50°C ΔT in compliance with BSEN442.  
Watts and Btu's apply to Heating and Dual Fuel only.  
For details on up-grading from standard elements to Thermostatic or Remote Control, please see page 399. Please see pages 400-401 for our range of valves.

**MS H DF E**

	Height	Width	Depth	Bars	Watts	Btu/hr	
<b>KIN1200500CP</b>	1200	500	93	3-3-3	834	2846	£905.00
<b>KIN1200600CP</b>	1200	600	93	3-3-3	1033	3525	£983.00
<b>KIN1500500CP</b>	1500	500	93	3-3-3-3	1145	3907	£1057.00
<b>KIN1500600CP</b>	1500	600	93	3-3-3-3	1438	4906	£1140.00



Chrome 772 x 500mm PA0772500CP  
 Chrome 772 x 600mm PA0772600CP  
 Chrome 1186 x 500mm PA1186500CP  
 Chrome 1508 x 500mm PA1508500CP  
 Chrome 1738 x 500mm PA1738500CP



Chrome + White 1200 x 500mm KIN1200500CP  
 Chrome + White 1200 x 600mm KIN1200600CP  
 Chrome + White 1500 x 500mm KIN1500500CP  
 Chrome + White 1500 x 600mm KIN1500600CP

All dimensions in mm. All measurements are approximate and subject to standard tolerances.

INSTINCT®

Designer Towel Rails

**Heating option supplement applies across all Designer Towel Rails**

<b>PHG-HE-SUPP</b>	Dual fuel add on cost	£91.00
<b>PHG-EO-SUPP</b>	Sealed Electric add on cost	£243.00

**Guarantees**

**15** Years on Hemsworth

# Hemsworth



**Hemsworth**

Finish – Chrome and White

Material – Mild Steel

All heat outputs are shown at 50°C ΔT in compliance with BSEN442.

Please see pages 400-401 for our range of valves.

**MS H DF E**

	Height	Width	Depth	Face to Face Connections	Watts	Btu/hr	
<b>HE9654C</b>	963	538	230	393	392	1338	£459.00
<b>HE9667C</b>	963	673	230	528	554	1890	£517.00
<b>HE9676C</b>	963	763	230	618	653	2228	£680.00
<b>KENFW150050CP</b>	1500	500	250	355	815	2781	£783.00

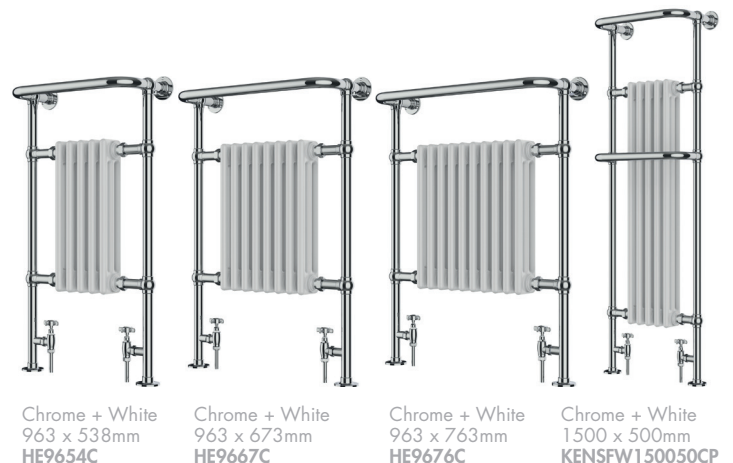



# Nostell

Guarantees

**10** Years on Nostell

Vertical Radiators



Matt Black  
1800 x 400mm  
NOS1800400MB



Matt White  
1800 x 400mm  
NOS1800400MW

**Vertical Panel**

Finish – Anthracite, Matt Black or Matt White Material – Aluminium  
All heat outputs are shown at 50°C ΔT in compliance with BSEN442.  
Please see pages 400-401 for our range of valves.

**AL** **H**

**Anthracite Finish**

	Height	Width	Depth	End to End Connections	Watts	Btu/hr	
NOS1800280AT	1800	280	118	280	1335	4555	£984.00
NOS1800400AT	1800	400	118	400	1869	6377	£1278.00
NOS1800520AT	1800	520	118	520	2403	8199	£1592.00

**Matt Black Finish**

	Height	Width	Depth	End to End Connections	Watts	Btu/hr	
NOS1800280MB	1800	280	118	280	1335	4555	£952.00
NOS1800400MB	1800	400	118	400	1869	6377	£1256.00
NOS1800520MB	1800	520	118	520	2403	8199	£1564.00



**Matt White Finish**

	Height	Width	Depth	End to End Connections	Watts	Btu/hr	
NOS1800280MW	1800	280	118	280	1355	4555	£928.00
NOS1800400MW	1800	400	118	400	1869	6377	£1223.00
NOS1800520MW	1800	520	118	520	2403	8199	£1522.00

Guarantees

**10** Years  
on Nostell

Horizontal Radiators



Horizontal Panel

Finish – Anthracite, Matt Black or Matt White Material – Aluminium  
All heat outputs are shown at 50°C ΔT in compliance with BSEN442.  
Please see pages 400-401 for our range of valves.

**AL** **H**

Anthracite Finish							
	Height	Width	Depth	End to End Connections	Watts	Btu/hr	
NOS0600640AT	600	640	118	640	1023	3490	£870.00
NOS0600760AT	600	760	118	760	1209	4125	£1001.00
NOS0600100AT	600	1000	118	1000	1581	5394	£1263.00
NOS0600124AT	600	1240	118	1240	1953	6664	£1534.00
NOS0600136AT	600	1360	118	1360	2139	7298	£1666.00

Matt Black Finish							
	Height	Width	Depth	End to End Connections	Watts	Btu/hr	
NOS0600640MB	600	640	118	640	1023	3490	£856.00
NOS0600760MB	600	760	118	760	1209	4125	£984.00
NOS0600100MB	600	1000	118	1000	1581	5394	£1242.00
NOS0600124MB	600	1240	118	1240	1953	6664	£1507.00
NOS0600136MB	600	1360	118	1360	2139	7298	£1636.00

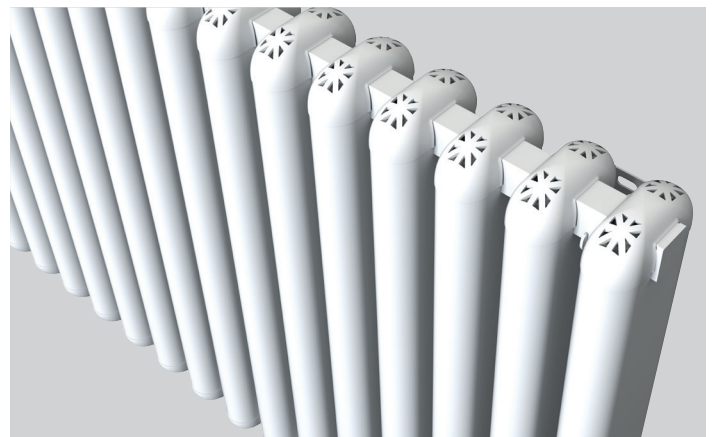

Matt White Finish							
	Height	Width	Depth	End to End Connections	Watts	Btu/hr	
NOS0600640MW	600	640	118	640	1023	3490	£834.00
NOS0600760MW	600	760	118	760	1209	4125	£959.00
NOS0600100MW	600	1000	118	1000	1581	5394	£1209.00
NOS0600124MW	600	1240	118	1240	1953	6664	£1467.00
NOS0600136MW	600	1360	118	1360	2139	7298	£1591.00

# Lissett

Guarantees

**10** Years  
on Lissett



Matt Black  
1800 x 490mm  
LISS1800490MB



Matt White  
1800 x 490mm  
LISS1800490MW

## Vertical Panel

Finish – Anthracite, Matt Black or Matt White Material – Aluminium  
All heat outputs are shown at 50°C ΔT in compliance with BSEN442.  
Please see pages 400-401 for our range of valves.

**AL** **H**

### Anthracite Finish

	Height	Width	Depth	End to End Connections	Watts	Btu/hr	
LISS1800380AT	1800	380	108-117	380	1519	5183	£1176.00
LISS1800490AT	1800	490	108-117	490	1953	6664	£1458.00
LISS1800600AT	1800	600	108-117	600	2387	8144	£1739.00

### Matt Black Finish

	Height	Width	Depth	End to End Connections	Watts	Btu/hr	
LISS1800380MB	1800	380	108-117	380	1519	5183	£1155.00
LISS1800490MB	1800	490	108-117	490	1953	6664	£1429.00
LISS1800600MB	1800	600	108-117	600	2387	8144	£1708.00

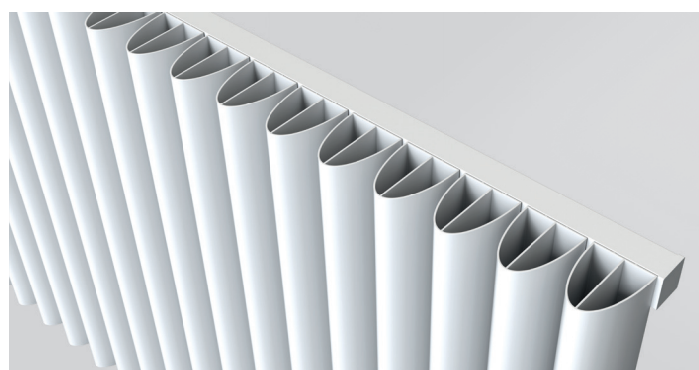

### Matt White Finish

	Height	Width	Depth	End to End Connections	Watts	Btu/hr	
LISS1800380MW	1800	380	108-117	380	1519	5183	£1125.00
LISS1800490MW	1800	490	108-117	490	1953	6664	£1393.00
LISS1800600MW	1800	600	108-117	600	2387	8144	£1662.00

# Lisett

## Guarantees

**10** Years  
on Lisett



## Horizontal Panel

Finish – Anthracite, Matt Black or Matt White Material – Aluminium  
All heat outputs are shown at 50°C ΔT in compliance with BSEN442.  
Please see pages 400-401 for our range of valves.

**AL** **H**

Anthracite Finish							
	Height	Width	Depth	End to End Connections	Watts	Btu/hr	
LIS0600600AT	575	600	108-117	600	836	2852	£796.00
LIS0600820AT	575	820	108-117	820	1140	3890	£1008.00
LIS0600104AT	575	1040	108-117	1040	1444	4927	£1266.00
LIS0600120AT	575	1205	108-117	1205	1672	5705	£1450.00
LIS0600142AT	575	1425	108-117	1425	1976	6742	£1685.00

Matt Black Finish							
	Height	Width	Depth	End to End Connections	Watts	Btu/hr	
LIS0600600MB	575	600	108-117	600	836	2852	£783.00
LIS0600820MB	575	820	108-117	820	1140	3890	£1013.00
LIS0600104MB	575	1040	108-117	1040	1444	4927	£1244.00
LIS0600120MB	575	1205	108-117	1205	1672	5705	£1425.00
LIS0600142MB	575	1425	108-117	1425	1976	6742	£1655.00



Matt White Finish							
	Height	Width	Depth	End to End Connections	Watts	Btu/hr	
LIS0600600MW	575	600	108-117	600	836	2852	£763.00
LIS0600820MW	575	820	108-117	820	1140	3890	£987.00
LIS0600104MW	575	1040	108-117	1040	1444	4927	£1211.00
LIS0600120MW	575	1205	108-117	1205	1672	5705	£1387.00
LIS0600142MW	575	1425	108-117	1425	1976	6742	£1610.00

# Ovate

Guarantees

**15** Years  
on Ovate



White  
1800 x 352mm  
OV-D180352WH



Anthracite  
1800 x 352mm  
OV-D180352AT

### Ovate Double

Finish – White or Anthracite Material – Mild Steel  
All heat outputs are shown at 50°C ΔT in compliance with BSEN442.  
Please see pages 400-401 for our range of valves.

**MS** **H**

White Finish						
	Height	Width	Depth	End to End Connections	Watts	Btu/hr
OV-D180352WH	1800	352	105-110	352	1014	3460 £610.00

Anthracite Finish						
	Height	Width	Depth	End to End Connections	Watts	Btu/hr
OV-D180352AT	1800	352	105-110	352	1014	3460 £610.00

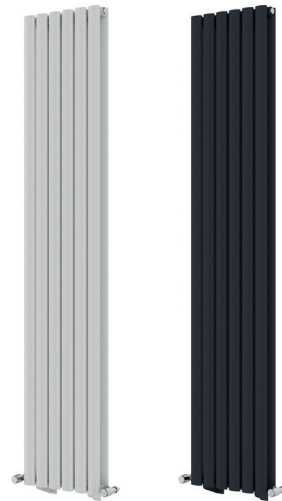

White  
1800 x 352mm  
OV-D180352WH

Anthracite  
1800 x 352mm  
OV-D180352AT

Guarantees

**15** Years on Adore

# Adore



**Adore**

Finish – White Material – Mild Steel  
All heat outputs are shown at 50°C ΔT in compliance with BSEN442. For details on up-grading from standard elements to Thermostatic or Remote Control, please see page 399. Please see pages 400-401 for our range of valves.

**MS H**

**2 Column Radiators**

	Height	Width	Depth	No. of Sections	Watts	Btu/hr	
AD2C-050-22-0988	500	988	68	22	817	2788	£535.00
AD2C-060-10-0460	600	460	68	10	440	1501	£259.00
AD2C-060-14-0636	600	636	68	14	616	2102	£354.00
AD2C-060-18-0812	600	812	68	18	792	2702	£450.00
AD2C-060-28-1252	600	1252	68	28	1232	4204	£555.00
AD2C-060-22-0988	600	988	68	22	968	3303	£608.00
AD2C-180-06-0284	1800	284	68	6	774	2641	£343.00
AD2C-180-08-0372	1800	372	68	8	1032	3521	£446.00
AD2C-180-10-0460	1800	460	68	10	1290	4401	£549.00
AD2C-180-12-0548	1800	548	68	12	1548	5282	£652.00

**3 Column Radiators**

	Height	Width	Depth	No. of Sections	Watts	Btu/hr	
AD3C-050-22-0988	500	988	100	22	1131	3859	£660.00
AD3C-050-28-1252	500	1252	100	28	1440	4913	£830.00
AD3C-060-14-0636	600	636	100	14	852	2907	£455.00
AD3C-060-20-0900	600	900	100	20	1218	4156	£640.00
AD3C-060-24-1076	600	1076	100	24	1462	4988	£763.00
AD3C-060-30-1340	600	1340	100	30	1827	6234	£937.00
AD3C-075-10-0460	750	460	100	10	750	2559	£391.00
AD3C-075-14-0636	750	636	100	14	1050	3583	£527.00
AD3C-180-08-0372	1800	372	100	8	1412	4818	£562.00
AD3C-180-10-0460	1800	460	100	10	1764	6019	£686.00
AD3C-180-12-0548	1800	548	100	12	2117	7223	£798.00

**4 Column Radiators**

	Height	Width	Depth	No. of Sections	Watts	Btu/hr	
AD4C-030-30-1340	300	1340	140	30	1275	4350	£2327.00
AD4C-060-20-0900	600	900	140	20	1638	5589	£808.00



# Medley

Guarantees

**15** Years  
on Medley



White  
1800 x 507mm  
ME1851W



11 Section Radiator – Anthracite



Towel Bar – Chrome

### Medley Towel Bar

Finish – Chrome

<b>ME034 200CP</b>	200mm	£71.00
<b>ME034 340CP</b>	340mm	£77.00
<b>ME034 480CP</b>	480mm	£82.00

## Medley

Finish – Anthracite or White Material – Mild Steel  
All heat outputs are shown at 50°C ΔT in compliance with BSEN442.  
Please see pages 400-401 for our range of valves.

**MS** **H**

### Vertical – Anthracite Finish

	Height	Width	Depth	Sections	End to End Connections	Watts	Btu/hr	
<b>ME1823A</b>	1800	229	90	3	229	922	3146	£333.00
<b>ME1837A</b>	1800	370	90	5	370	1538	5248	£535.00
<b>ME1851A</b>	1800	507	90	7	507	2153	7346	£720.00

### Horizontal – Anthracite Finish

	Height	Width	Depth	Sections	End to End Connections	Watts	Btu/hr	
<b>ME4505A</b>	450	507	90	7	507	398	1358	£309.00
<b>ME4507A</b>	450	785	90	11	785	625	2133	£466.00
<b>ME4509A</b>	450	993	90	14	993	796	2716	£594.00
<b>ME4512A</b>	450	1202	90	17	1202	966	3296	£721.00
<b>ME5505A</b>	550	507	90	7	507	505	1723	£341.00
<b>ME5507A</b>	550	785	90	11	785	793	2706	£536.00
<b>ME5509A</b>	550	993	90	14	993	1009	3443	£665.00
<b>ME5512A</b>	550	1202	90	17	1202	1226	4183	£810.00

### Vertical – White Finish

	Height	Width	Depth	Sections	End to End Connections	Watts	Btu/hr	
<b>ME1823W</b>	1800	229	90	3	229	922	3147	£320.00
<b>ME1837W</b>	1800	370	90	5	370	1538	5248	£514.00
<b>ME1851W</b>	1800	507	90	7	507	2153	7346	£691.00

### Horizontal – White Finish

	Height	Width	Depth	Sections	End to End Connections	Watts	Btu/hr	
<b>ME4505W</b>	450	507	90	7	507	398	1358	£281.00
<b>ME4507W</b>	450	785	90	11	785	625	2133	£425.00
<b>ME4509W</b>	450	993	90	14	993	796	2716	£564.00
<b>ME4512W</b>	450	1202	90	17	1202	966	3296	£657.00
<b>ME5505W</b>	550	507	90	7	507	505	1723	£324.00
<b>ME5507W</b>	550	785	90	11	785	793	2706	£489.00
<b>ME5509W</b>	550	993	90	14	993	1009	3443	£623.00
<b>ME5512W</b>	550	1202	90	17	1202	1226	4183	£757.00

# Symphony

## Guarantees

**15** Years on Symphony

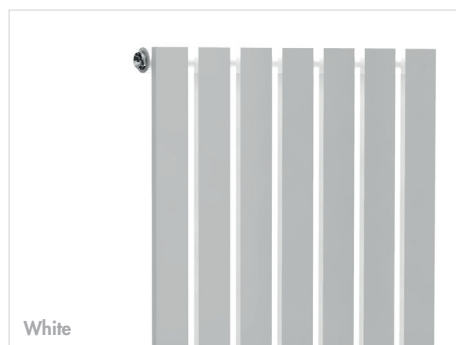
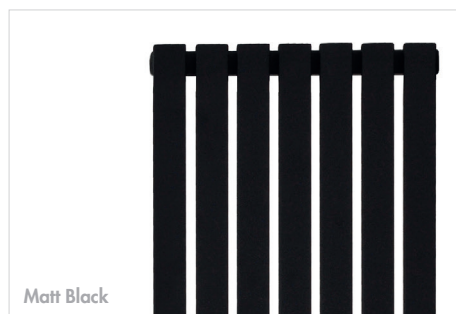
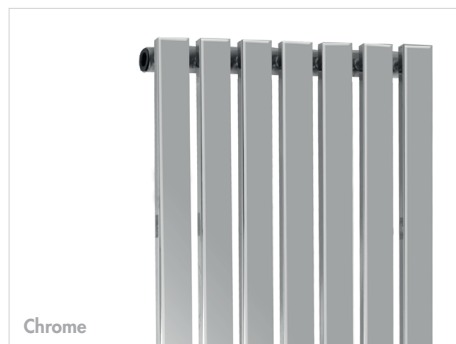

## Symphony

Finish – Chrome, Matt Black or White Material – Mild Steel  
All heat outputs are shown at 50°C ΔT in compliance with BSEN442.  
Please see pages 400-401 for our range of valves.

**MS** **H**

Chrome Finish								
	Height	Width	Depth	Bars	End to End Connections	Watts	Btu/hr	
<b>SY1225C</b>	1200	252	70	5	252	242	826	£344.00
<b>SY1235C</b>	1200	358	70	7	358	339	1157	£399.00
<b>SY1825C</b>	1800	252	70	5	252	252	1198	£567.00
<b>SY1835C</b>	1800	358	70	7	358	358	1675	£617.00

Matt Black Finish								
	Height	Width	Depth	Bars	End to End Connections	Watts	Btu/hr	
<b>SY1225B</b>	1200	252	70	5	252	252	1252	£280.00
<b>SY1235B</b>	1200	358	70	7	358	358	1757	£313.00
<b>SY1825B</b>	1800	252	70	5	252	252	1819	£338.00
<b>SY1835B</b>	1800	358	70	7	358	358	2545	£403.00

White Finish								
	Height	Width	Depth	Bars	End to End Connections	Watts	Btu/hr	
<b>SY1225W</b>	1200	252	70	5	252	367	1252	£280.00
<b>SY1235W</b>	1200	358	70	7	358	515	1757	£313.00
<b>SY1825W</b>	1800	252	70	5	252	533	1819	£338.00
<b>SY1835W</b>	1800	358	70	7	358	746	2545	£403.00

## Symphony Towel Bar

Finish – Chrome

<b>SY039A 266CP</b>	266mm	£73.00
<b>SY039B 375CP</b>	375mm	£82.00





# Alumina

Guarantees

**10** Years  
on Alumina

Vertical Single + Double Radiators



Anthracite  
1800 x 375mm  
ALV-180375AT



White  
1800 x 466mm  
ALVDP-180466WH

### Single Vertical Panel

Finish – White or Anthracite Material – Aluminium  
All heat outputs are shown at 50°C ΔT in compliance with BSEN442.  
Please see pages 400-401 for our range of valves.

**AL** **H**

White Finish							
	Height	Width	Depth	End to End Connections	Watts	Btu/hr	
ALV-180280WH	1800	280	76.5	280	843	2876	£355.00
ALV-180375WH	1800	375	76.5	375	1124	3835	£454.00
ALV-180470WH	1800	470	76.5	470	1405	4794	£552.00

Anthracite Finish							
	Height	Width	Depth	End to End Connections	Watts	Btu/hr	
ALV-180280AT	1800	280	76.5	280	843	2876	£370.00
ALV-180375AT	1800	375	76.5	375	1124	3835	£473.00
ALV-180470AT	1800	470	76.5	470	1405	4794	£577.00

### Double Vertical Panel

Finish – White or Anthracite Material – Aluminium  
All heat outputs are shown at 50°C ΔT in compliance with BSEN442.  
Please see pages 400-401 for our range of valves.

**AL** **H**

White Finish							
	Height	Width	Depth	End to End Connections	Watts	Btu/hr	
ALVDP-180278WH	1800	278	117.5	278	1441	4917	£538.00
ALVDP-180372WH	1800	372	117.5	372	1916	6537	£686.00
ALVDP-180466WH	1800	466	117.5	466	2348	8011	£834.00

Anthracite Finish							
	Height	Width	Depth	End to End Connections	Watts	Btu/hr	
ALVDP-180278AT	1800	278	117.5	278	1441	4917	£550.00
ALVDP-180372AT	1800	372	117.5	372	1916	6537	£704.00
ALVDP-180466AT	1800	466	117.5	466	2348	8011	£857.00

Guarantees

**10** Years  
on Alumina

# Alumina

## Horizontal Single + Double Radiators



### Single Horizontal Panel

Finish – White or Anthracite Material – Aluminium  
All heat outputs are shown at 50°C ΔT in compliance with BSEN442.  
Please see pages 400-401 for our range of valves.

**AL H**

White Finish							
	Height	Width	Depth	End to End Connections	Watts	Btu/hr	
ALH-0600565WH	600	565	76.5	565	506	1726	£331.00
ALH-0600755WH	600	755	76.5	755	674	2300	£421.00
ALH-0600945WH	600	945	76.5	945	842	2873	£513.00
ALH-0601135WH	600	1135	76.5	1135	1011	3450	£604.00
ALH-0601325WH	600	1325	76.5	1325	1147	3914	£694.00
ALH-0601515WH	600	1515	76.5	1515	1342	4579	£785.00

Anthracite Finish							
	Height	Width	Depth	End to End Connections	Watts	Btu/hr	
ALH-0600565AT	600	565	76.5	565	506	1726	£342.00
ALH-0600755AT	600	755	76.5	755	674	2300	£433.00
ALH-0600945AT	600	945	76.5	945	842	2873	£531.00
ALH-0601135AT	600	1135	76.5	1135	1011	3450	£627.00
ALH-0601325AT	600	1325	76.5	1325	1147	3914	£719.00
ALH-0601515AT	600	1515	76.5	1515	1342	4579	£814.00

### Double Horizontal Panel

Finish – White or Anthracite Material – Aluminium  
All heat outputs are shown at 50°C ΔT in compliance with BSEN442.  
Please see pages 400-401 for our range of valves.

**AL H**

White Finish							
	Height	Width	Depth	End to End Connections	Watts	Btu/hr	
ALHDP-0600560WH	600	560	117.5	560	841	2869	£453.00
ALHDP-0600748WH	600	748	117.5	748	1121	3825	£577.00
ALHDP-0600936WH	600	936	117.5	936	1401	4780	£701.00
ALHDP-0601124WH	600	1124	117.5	1124	1654	5643	£851.00
ALHDP-0601312WH	600	1312	117.5	1312	1908	6510	£979.00

Anthracite Finish							
	Height	Width	Depth	End to End Connections	Watts	Btu/hr	
ALHDP-0600560AT	600	560	117.5	560	841	2869	£462.00
ALHDP-0600748AT	600	748	117.5	748	1121	3825	£590.00
ALHDP-0600936AT	600	936	117.5	936	1401	4780	£718.00
ALHDP-0601124AT	600	1124	117.5	1124	1654	5643	£870.00
ALHDP-0601312AT	600	1312	117.5	1312	1908	6510	£1002.00

# Espada Aluminium

Guarantees

**10** Years  
on Espada Aluminium

Vertical Radiators



White  
1800 x 520mm  
ESAL-V1800514WH



Anthracite  
1800 x 520mm  
ESAL-V1800514AT

### Single Vertical Panel

Finish – White or Anthracite Material – Aluminium  
All heat outputs are shown at 50°C ΔT in compliance with BSEN442.  
Please see pages 400-401 for our range of valves.

**AL** **H**

**White Finish**

	Height	Width	Depth	End to End Connections	Watts	Btu/hr	
ESAL-V1800218WH	1800	218	66	220	642	2190	£340.00
ESAL-V1800366WH	1800	366	66	370	1070	3651	£517.00
ESAL-V1800514WH	1800	514	66	520	1499	5113	£693.00
ESAL-V1800662WH	1800	662	66	670	1927	6574	£869.00

**Anthracite Finish**

	Height	Width	Depth	End to End Connections	Watts	Btu/hr	
ESAL-V1800218AT	1800	218	66	220	642	2190	£340.00
ESAL-V1800366AT	1800	366	66	370	1070	3651	£517.00
ESAL-V1800514AT	1800	514	66	520	1499	5113	£693.00
ESAL-V1800662AT	1800	662	66	670	1927	6574	£869.00

### Double Vertical Panel

Finish – White or Anthracite Material – Aluminium  
All heat outputs are shown at 50°C ΔT in compliance with BSEN442.  
Please see pages 400-401 for our range of valves.

**AL** **H**

**White Finish**

	Height	Width	Depth	End to End Connections	Watts	Btu/hr	
ESAL-VDP1800218WH	1800	218	91.5	220	1109	3783	£469.00
ESAL-VDP1800366WH	1800	366	91.5	370	1849	6308	£728.00
ESAL-VDP1800514WH	1800	514	91.5	520	2589	8833	£987.00
ESAL-VDP1800662WH	1800	662	91.5	670	3329	11358	£1247.00

**Anthracite Finish**

	Height	Width	Depth	End to End Connections	Watts	Btu/hr	
ESAL-VDP1800218AT	1800	218	91.5	220	1109	3783	£469.00
ESAL-VDP1800366AT	1800	366	91.5	370	1849	6308	£728.00
ESAL-VDP1800514AT	1800	514	91.5	520	2589	8833	£987.00
ESAL-VDP1800662AT	1800	662	91.5	670	3329	11358	£1247.00

**Guarantees**

**10** Years on Espada Aluminium

# Espada Aluminium

## Horizontal Radiators



White  
595 x 900mm  
ESAL-HDP0588900WH



Anthracite  
595 x 900mm  
ESAL-HDP0588900AT

### Single Horizontal Panel

Finish – White or Anthracite Material – Aluminium  
All heat outputs are shown at 50°C ΔT in compliance with BSEN442.  
Please see pages 400-401 for our range of valves.

**AL** **H**

White Finish							
	Height	Width	Depth	Pipe Centres	Watts	Btu/hr	
ESAL-H0440900WH	440	900	75	870	680	2319	£361.00
ESAL-H04401200WH	440	1200	75	1150	881	3006	£442.00
ESAL-H0588900WH	588	900	75	870	906	3092	£458.00
ESAL-H05881200WH	588	1200	75	1150	1175	4009	£566.00

Anthracite Finish							
	Height	Width	Depth	Pipe Centres	Watts	Btu/hr	
ESAL-H0440900AT	440	900	75	870	680	2319	£361.00
ESAL-H04401200AT	440	1200	75	1150	881	3006	£442.00
ESAL-H0588900AT	588	900	75	870	906	3092	£458.00
ESAL-H05881200AT	588	1200	75	1150	1175	4009	£566.00

### Double Horizontal Panel

Finish – White or Anthracite Material – Aluminium  
All heat outputs are shown at 50°C ΔT in compliance with BSEN442.  
Please see pages 400-401 for our range of valves.

**AL** **H**

White Finish							
	Height	Width	Depth	Pipe Centres	Watts	Btu/hr	
ESAL-HDP0440900WH	440	900	122	870	1161	3960	£521.00
ESAL-HDP04401200WH	440	1200	122	1150	1513	5163	£633.00
ESAL-HDP0588900WH	588	900	122	870	1548	5281	£671.00
ESAL-HDP05881200WH	588	1200	122	1150	2018	6886	£819.00

Anthracite Finish							
	Height	Width	Depth	Pipe Centres	Watts	Btu/hr	
ESAL-HDP0440900AT	440	900	122	870	1161	3960	£521.00
ESAL-HDP04401200AT	440	1200	122	1150	1513	5163	£633.00
ESAL-HDP0588900AT	588	900	122	870	1548	5281	£671.00
ESAL-HDP05881200AT	588	1200	122	1150	2018	6886	£819.00

# Espada

Guarantees

**15** Years on Espada

Vertical Radiators



White  
1800 x 528mm  
ES-VDP180524WH



Double – White

### Single Panel

Finish – White or Anthracite Material – Mild Steel  
All heat outputs are shown at 50°C ΔT in compliance with BSEN442.  
Please see pages 400-401 for our range of valves.

**MS H**

**White Finish**

	Height	Width	Depth	Watts	Btu/hr	
ES-V180228WH	1800	224	71	402	1372	£278.00
ES-V180376WH	1800	376	71	670	2286	£379.00
ES-V180524WH	1800	528	71	938	3200	£480.00
ES-V180672WH	1800	680	71	1206	4115	£580.00

**Anthracite Finish**

	Height	Width	Depth	Watts	Btu/hr	
ES-V180228AT	1800	224	71	402	1372	£281.00
ES-V180376AT	1800	376	71	670	2286	£383.00
ES-V180524AT	1800	528	71	938	3200	£484.00
ES-V180672AT	1800	680	71	1206	4115	£586.00

### Double Panel

Finish – White or Anthracite Material – Mild Steel  
All heat outputs are shown at 50°C ΔT in compliance with BSEN442.  
Please see pages 400-401 for our range of valves.

**MS H**

**White Finish**

	Height	Width	Depth	Watts	Btu/hr	
ES-VDP180228WH	1800	224	71	627	2139	£439.00
ES-VDP180376WH	1800	376	71	1045	3566	£640.00
ES-VDP180524WH	1800	528	71	1463	4992	£841.00
ES-VDP180672WH	1800	680	71	1881	6418	£1042.00

**Anthracite Finish**

	Height	Width	Depth	Watts	Btu/hr	
ES-VDP180228AT	1800	224	71	627	2139	£466.00
ES-VDP180376AT	1800	376	71	1045	3566	£678.00
ES-VDP180524AT	1800	528	71	1463	4992	£891.00
ES-VDP180672AT	1800	680	71	1881	6418	£1103.00

# Espada

## Guarantees

**15** Years  
on Espada

## Horizontal Radiators



### Single Panel

Finish – White or Anthracite Material – Mild Steel  
All heat outputs are shown at 50°C ΔT in compliance with BSEN442.  
Please see pages 400-401 for our range of valves.

**MS** **H**

White Finish						
	Height	Width	Depth	Watts	Btu/hr	
ES-H0450090WH	452	900	63	420	1433	£314.00
ES-H0450120WH	452	1200	63	552	1883	£355.00
ES-H0598090WH	604	900	63	560	1911	£380.00
ES-H0598120WH	604	1200	63	736	2511	£434.00

Anthracite Finish						
	Height	Width	Depth	Watts	Btu/hr	
ES-H0450090AT	452	900	63	420	1433	£317.00
ES-H0450120AT	452	1200	63	552	1883	£359.00
ES-H0598090AT	604	900	63	560	1911	£384.00
ES-H0598120AT	604	1200	63	736	2511	£438.00

### Double Panel

Finish – White or Anthracite Material – Mild Steel  
All heat outputs are shown at 50°C ΔT in compliance with BSEN442.  
Please see pages 400-401 for our range of valves.

**MS** **H**

White Finish						
	Height	Width	Depth	Watts	Btu/hr	
ES-HDP0450090WH	452	900	112	654	2231	£532.00
ES-HDP0450120WH	452	1200	112	858	2927	£607.00
ES-HDP0598090WH	604	900	112	872	2975	£668.00
ES-HDP0598120WH	604	1200	112	1144	3903	£766.00

Anthracite Finish						
	Height	Width	Depth	Watts	Btu/hr	
ES-HDP0450090AT	452	900	112	654	2231	£536.00
ES-HDP0450120AT	452	1200	112	858	2927	£612.00
ES-HDP0598090AT	604	900	112	872	2975	£672.00
ES-HDP0598120AT	604	1200	112	1144	3903	£770.00

# Coloured Valves + Elements

**Guarantees**

**2** Years on Coloured Valves + Elements

## Coloured Valves



Brushed Brass  
INCNT003ST-ZBBS

### Straight Valves (1/2" x 15mm)

INCNT003ST-ZBBS	Brushed Brass	£48.00
INCNT003ST-ZGM	Gunmetal	£48.00
INCNT003ST-ZBN	Satin Brushed Nickel	£48.00
INCNT003ST-BBZ	Brushed Bronze	£48.00



Gunmetal INCNT003ST-ZGM Satin Brushed Nickel INCNT003ST-ZBN Brushed Bronze INCNT003ST-BBZ Moss Green INCNT003ST-ZMGN Steel Blue INCNT003ST-ZSBLU



Espresso INCNT003ST-ZEX White Sparkle INCNT003ST-ZWS Grey Sparkle INCNT003ST-ZGS Satin Black INCNT003ST-ZSB Cappuccino INCNT003ST-ZCA Gloss White INCNT003ST-GW

### Straight Valves (1/2" x 15mm)

INCNT003ST-ZMGN	Moss Green	£48.00
INCNT003ST-ZSBLU	Steel Blue	£48.00
INCNT003ST-ZEX	Espresso	£48.00
INCNT003ST-ZWS	White Sparkle	£48.00

### Straight Valves (1/2" x 15mm)

INCNT003ST-ZGS	Grey Sparkle	£48.00
INCNT003ST-ZSB	Satin Black	£48.00
INCNT003ST-ZCA	Cappuccino	£48.00
<b>new</b> INCNT003ST-GW	Gloss White	£48.00

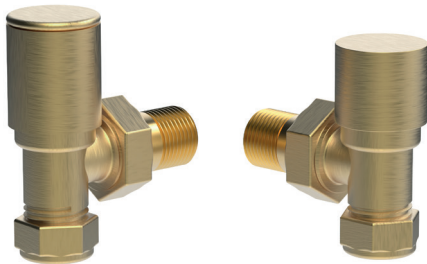

Brushed Brass  
INCNT003AP-ZBBS

### Angled Valves (1/2" x 15mm)

INCNT003AP-ZBBS	Brushed Brass	£48.00
INCNT003AP-ZGM	Gunmetal	£48.00
INCNT003AP-ZBN	Satin Brushed Nickel	£48.00
INCNT003AP-BBZ	Brushed Bronze	£48.00



Gunmetal INCNT003AP-ZGM Satin Brushed Nickel INCNT003AP-ZBN Brushed Bronze INCNT003AP-BBZ Moss Green INCNT003AP-ZMGN Steel Blue INCNT003AP-ZSBLU



Espresso INCNT003AP-ZEX White Sparkle INCNT003AP-ZWS Grey Sparkle INCNT003AP-ZGS Satin Black INCNT003AP-ZSB Cappuccino INCNT003AP-ZCA Gloss White INCNT003AP-GW

### Angled Valves (1/2" x 15mm)

INCNT003AP-ZMGN	Moss Green	£48.00
INCNT003AP-ZSBLU	Steel Blue	£48.00
INCNT003AP-ZEX	Espresso	£48.00
INCNT003AP-ZWS	White Sparkle	£48.00

### Angled Valves (1/2" x 15mm)

INCNT003AP-ZGS	Grey Sparkle	£48.00
INCNT003AP-ZSB	Satin Black	£48.00
INCNT003AP-ZCA	Cappuccino	£48.00
INCNT003AP-GW	Gloss White	£48.00

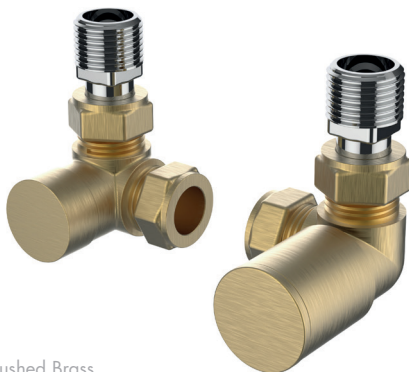

Brushed Brass  
INCNT023-BBS

### Corner Valves (1/2" x 15mm)

INCNT023-BBS	Brushed Brass	£58.00
INCNT023-GM	Gunmetal	£58.00
INCNT023-BN	Satin Brushed Nickel	£58.00
INCNT023-BBZ	Brushed Bronze	£58.00



Gunmetal INCNT023-GM Satin Brushed Nickel INCNT023-BN Brushed Bronze INCNT023-BBZ Moss Green INCNT023-MGN Steel Blue INCNT023-SBLU

Anthracite INCNT023-AT White Sparkle INCNT023-WS Grey Sparkle INCNT023-GS Matt Black INCNT023-MB Cappuccino INCNT023-CA Espresso INCNT023-EX

### Corner Valves (1/2" x 15mm)

INCNT023-MGN	Moss Green	£49.00
INCNT023-SBLU	Steel Blue	£49.00
INCNT023-AT	Anthracite	£49.00
INCNT023-WS	White Sparkle	£49.00

### Corner Valves (1/2" x 15mm)

INCNT023-GS	Grey Sparkle	£49.00
INCNT023-MB	Matt Black	£49.00
INCNT023-CA	Cappuccino	£49.00
INCNT023-EX	Espresso	£49.00

Guarantees

**2** Years on Coloured Valves + Elements

# Coloured Valves + Elements

## 15mm Pipe Connection Tubes (Pair)

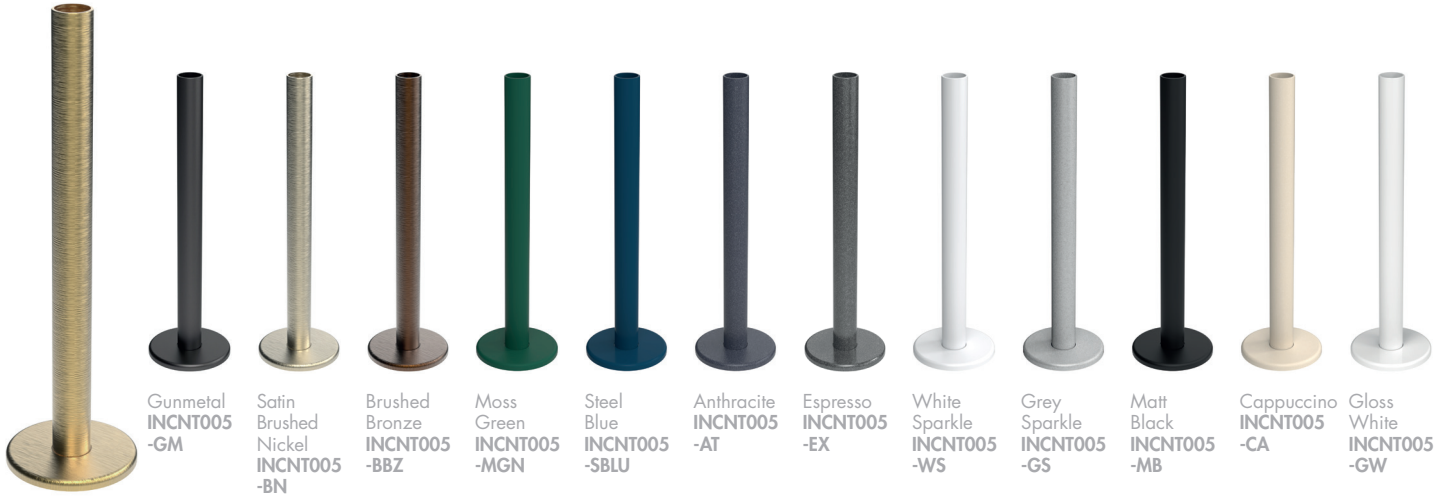

Brushed Brass  
INCNT005-BBS

<b>new</b> INCNT005-BBS	Brushed Brass	£37.00
<b>new</b> INCNT005-GM	Gunmetal	£37.00
<b>new</b> INCNT005-BN	Satin Brushed Nickel	£37.00
<b>new</b> INCNT005-BBZ	Brushed Bronze	£37.00

INCNT005-MGN	Moss Green	£37.00
INCNT005-SBLU	Steel Blue	£37.00
INCNT005-AT	Anthracite	£37.00
INCNT005-EX	Espresso	£37.00

INCNT005-WS	White Sparkle	£37.00
INCNT005-GS	Grey Sparkle	£37.00
INCNT005-MB	Matt Black	£37.00
INCNT005-CA	Cappuccino	£37.00
INCNT005-GW	Gloss White	£37.00

## Elements



### Standard Element IP55

A benchmark element to suit each size of product.

<b>PHG-EO-SUPP</b>	Electric Only	£243.00
<b>PHG-HE-SUPP</b>	Dual Fuel	£91.00

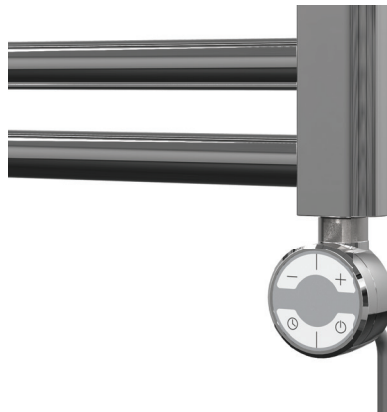

### Heat Sensor Element IPX5\*

An electronic temperature sensor control.

<b>PHG-EOHS</b>	Electric Only	£390.00
<b>PHG-DFHS</b>	Dual Fuel	£255.00

\*Optional cover shroud available PHG-AC040, ask for details.



### Remote Controlled Heat Element IPX4 NTC

– Negative Temperature Coefficient Technology

Remote controlled programmable element for adjustable temperature control via App or remote control (see below).

<b>SEE005-0300CP</b>	NTC IPX4 300W	£261.00
<b>SEE005-0600CP</b>	NTC IPX4 600W	£265.00

### Remote Control

Remote control for heat element IPX4 NTC.

<b>SEE005-REMOTE</b>	£78.00
----------------------	--------



### 15mm Dual Fuel Corner Radiator Valves (Pair)

Finish – Polished Chrome  
Dimensions – 71.8(h) x 64.3(w) x 68.5/48.3(d) mm

<b>INST-AL049LC</b>	£47.00
---------------------	--------

### Towel Rail Element including Tee Piece + 1/2" Plug

Suitable for both dual-fuel and electric only  
Maintains liquid temperature between 40-54°C

<b>TRE150</b>	150W	£51.00
<b>TRE250</b>	250W	£53.00
<b>TRE400</b>	400W	£55.00
<b>TRE600</b>	600W	£57.00
<b>TRE800</b>	800W	£66.00

### 1/2" M + F Dual Fuel Elbow

Finish – Chrome

<b>DFE12</b>	£8.00
--------------	-------





## Valves

Guarantees

1 Year  
on Valves**Modern 15mm Angled Radiator Valves (Pair)**

Finish – Polished Chrome  
Dimensions – 90.5(h) x 75(w) x 32(d) mm

INST-AL025LC

£24.00

**Modern 15mm Straight Radiator Valves (Pair)**

Finish – Polished Chrome  
Dimensions – 75(h) x 87.5(w) x 32(d) mm

INST-AL024LC

£25.00

**Crosshead Angled Traditional Radiator Valve 1/2" x 15mm (Pair)**

Finish – Polished Chrome  
Dimensions – 110(h) x 115(w) x 46(d) mm

INST-AL034LC

£40.00

**Square 15mm Decorative Angled Radiator Valves (Pair)**

Finish – Polished Chrome  
Dimensions – 82(h) x 76(w) x 30(d) mm

INST-AL030LC

£67.00

**Square 15mm Decorative Straight Radiator Valves (Pair)**

Finish – Polished Chrome  
Dimensions – 64(h) x 95(w) x 30(d) mm

INST-AL031LC

£67.00

**Art Deco Angled Radiator Valve 1/2" x 15mm (Pair)**

Finish – Chrome  
Dimensions – 126(h) x 80(w) x 64(d) mm

INTRAD006

£90.00

**Contemporary Radiator Valves Angled 1/2" x 15mm**

Finish – Matt Black or Anthracite  
Dimensions – 78(h) x 75(w) x 30(d) mm

INCNT003AP-ZMB Matt Black £48.00

INCNT003AP-ZAT Anthracite £48.00

**Contemporary Radiator Valves Straight 1/2" x 15mm**

Finish – Matt Black or Anthracite  
Dimensions – 83(h) x 75(w) x 30(d) mm

INCNT003ST-ZMB Matt Black £48.00

INCNT003ST-ZAT Anthracite £48.00

**Classic Thermostatic 15mm Radiator Valve + Air Vent (Twin Pack)**

Finish – Polished Chrome  
Dimensions – 139(h) x 56(w) x 55(d) mm

INST-AL055LC

£84.00

# Valves

## Guarantees

**1** Year on Valves



### 15mm Angled TRV (Twin Pack)

Finish – Chrome  
Dimensions – 130(h) x 42(w) x 65(d) mm

15PACKACP.1

£35.00



### 15mm Straight TRV (Twin Pack)

Finish – Chrome  
Dimensions – 120(h) x 47(w) x 86(d) mm

15PACKSCP.1

£37.00



### 15mm Corner TRV + LS Pack

Finish – Chrome  
Dimensions – 117.75(h) x 39(w) x 15(d) mm

TRVCNR

£54.00



### Modern Thermostatic Radiator Valves Angled 1/2" x 15mm

Finish – Black or Anthracite  
Dimensions – 136(h) x 68(w) x 40(d) mm

INCNT004AP-BL Black £51.00

INCNT004AP-AT Anthracite £51.00



### Modern Thermostatic Radiator Valves Straight 1/2" x 15mm

Finish – Black or Anthracite  
Dimensions – 84(h) x 118(w) x 40(d) mm

INCNT004ST-BL Black £55.00

INCNT004ST-AT Anthracite £55.00



### Modern Thermostatic Corner Radiator Valves 1/2" x 15mm

Finish – Black or Anthracite  
Dimensions – 84(h) x 118(w) x 40(d) mm

INCNT024-BL Black £67.00

INCNT024-AT Anthracite £67.00



### Modern Thermostatic Radiator Valves Angled 1/2" x 15mm

Finish – Brushed Brass  
Dimensions – 136(h) x 68(w) x 40(d) mm

INCNT004AP-ZBBS £77.00



new

### 15mm Pipe Connection Tubes (Pair)

Finish – Chrome  
Dimensions – 150(h) x 15(w) x 15(d) mm

INCNT005-C

£19.00



### 15mm Corner Radiator Valves (Pair)

Finish – Polished Chrome  
Dimensions – 75(h) x 60(w) x 75(d) mm

INST-AL029LC

£36.00